

Peristaltic Cased Tube Pumps

Operating Manual

Verderflex Vantage 3000 C

EZ / S10 / R3i

Version
Print No.

2.0v-12/2013
01



Version 2.0v-12/2013
Print-No. 01

Verderflex Vantage3000 C
EZ / S10 / R3i



The information in this document is essential for the safe operation and servicing of Verderflex Vantage3000 pumps. This document must be read and understood thoroughly prior to installation of unit, electrical connection and commissioning.

Table of contents

1 About the product

- 1.1 Key features

2 Warranty

3 Pump returns

4 'EC' Declaration

5 Safety

- 5.1 Intended use
- 5.2 Prevention of obvious misuse

6 Maintenance

7 Pump head options and installation

- 7.1 Types of pump head
- 7.2 EZ head
 - 7.2.1 Key features
 - 7.2.2 Installing the tube
 - 7.2.3 Replacing the pump head
 - 7.2.4 Stacking pump head
- 7.3 S10 head
 - 7.3.1 Key features
 - 7.3.2 Installing the tube
- 7.4 R3i head
 - 7.4.1 Key features
 - 7.4.2 Installing the tube
 - 7.4.3 Changing rotor – R3i head

8 Functions

- 8.1 Adjusting pump speed
- 8.2 Analogue interface
- 8.3 IP66 Remote speed control

9 Remote Analogue/Digital Control

- 9.1 Types of remote control
- 9.2 Layout of back plate
- 9.3 External controls on different modules
- 9.4 Analogue connector
- 9.5 Foot/Hand switch control
 - 9.5.1 Connecting the foot switch
- 9.6 Analogue control
 - 9.6.1 Connecting analogue control systems
- 9.7 RS232 control
 - 9.7.1 Connector Layout
 - 9.7.2 Connector Description
 - 9.7.3 USB Driver installation and configuration

10 Declaration of conformity according to EC Machine Directive

Keypad Keys and symbols















Symbol	Meaning	Symbol	Meaning
	Start CW		Counter clock wise
	Start CCW		Clock wise
	Scroll up		Caution
	Scroll down		Set RPM
	Press		Enter
	Press and hold down		Maximum
	See		Stop

Table 1 Keypad Keys and symbols

1 About the product

i The Verderflex Vantage 3000® range of pumps deliver highly accurate and repeatable flow rates with a quick and easy setup. Vantage 3000 C is a manual/analogue control, easy tube load pump with stackable and multi channel pump head options and require low maintenance.

1.1 Key features

- Microprocessor controlled 24 hour duty with brushless dc motor
- Set precise dose requirement and calibrate to suit medium viscosity
- Stackable and multi channel head options
- Keypad operated with two line alpha numeric display.
- Volt free contacts for external Start/Stop/Reverse
- Manual and analogue control of speed/flow rate

2 Warranty

i The manufacturer does not accept any liability for damage resulting from disregard of this documentation.

This product is guaranteed to be free from defects in material or workmanship for a period of 24 months from date of purchase, excluding consumable items such as cartridges, tubing or rollers. Products out of guarantee period will be repaired for a nominal charge.

3 Pump returns

i All returned pumps must be decontaminated before being returned. The Decontamination Certificate is separately requested and must be returned before or with the pump delivery. For your protection, items returned must be carefully packed to prevent damage in transit and insured against loss.

4 'EC' Declaration

i The Vantage 3000 range, complies with EMC 2004/ 108/ EC as well as Machine Directive 2006/42/EC.

Installation of this pump into other equipment must be in accordance with relevant Directives/Standards and be carried out by a suitably competent person.

5 Safety

i The manufacturer does not accept any liability for damage resulting from disregard of this documentation.

5.1 Intended use

- Only use the pump to handle compatible fluids as recommended by the manufacturer.
- Adhere to the operating limits.
- Consult the manufacturer regarding any other use of the pump.

5.2 Prevention of obvious misuse

- Note the operating limits of the pump with regard to temperature, pressure, flow rate and motor speed.
- Do not operate the pump while the inlet/outlet valve is closed.
- Only install the pump as recommended in this manual. For example, the following are not allowed:
 - Installing the pump without proper support.
 - Installation in the immediate vicinity of extreme hot or cold sources.
- Do not use in conjunction with life support equipment
- Do not connect pump to the human body



Risk of electrocution!

- ▶ Make sure that the electrical information on the rating plate agrees with the power supply.
- ▶ Isolate the main supply before replacing the tube/cartridge
- ▶ Isolate the main supply before removing the enclosure cover

6 Maintenance

i Motor and Gearbox are lubricated for life and should not require attention. Rotor rollers are self-lubricated. Pump tubing will not last forever; establish suitable tube replacement schedule to prevent inconvenient tube failure

This pump contains no user serviceable parts and is factory sealed to confirm integrity. Pump warranty will be invalidated if the seal is broken.



Figure 1 Tamper proof label

7 Pump head options and Installation

- Pump should be installed by suitably qualified personnel
- Pump should be sited on stable horizontal surface
- Allow free flow of air around pump
- Tube should not be allowed to kink.

7.1 Types of pump head

Verderflex® Vantage 3000 pumps are available with the S10 pump head featured on the Verderflex Smart tube pump, as well as the R3i head featured on the Verderflex Rapide tube pump providing greater flow rates with stackable and multi channel head options.

		
1. EZ Head	2. R3i Head	3. S10 Head

Table 2 Vantage 3000 pump head options

7.2 EZ head

7.2.1 Key features

Easy tube change system, stackable multi head options with Verderprene, Silicone, Viton® or Tygon® tubing.

- Flow rates up to 1,310 ml/min (20.8 US GPH)
- Pressures up to 2 Bar (29 PSI)
- Typically used in frequent tube change applications

7.2.2 Installing the tube

1. Flip the lugs on both sides of the pump head to lift the top section
2. Once the head is lifted as shown in figure, insert the tube over the rollers.
3. Flip the lugs on both sides of the pump head to lock the top section down.
 - Adjust the tube clamp to hold the tube in place and avoid slip
 - Adjust the tube clamp on both sides of the pump head to the tube diameter.
 - If a tube slip is observed, tighten the tension on the clamps
 - Alternately, if a reduced flow is observed, reduce the clamp tension.

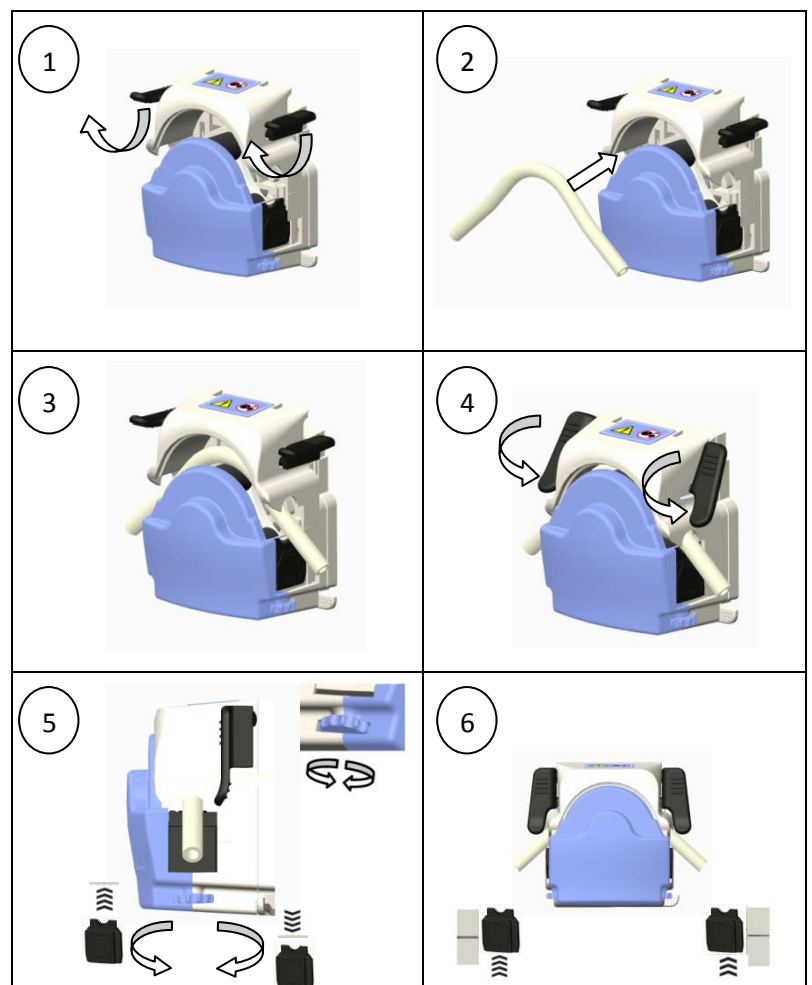

Table 3 Installing the tube

7.2.3 Replacing the pump head – EZ head

1. Offer pump head to backplate at angle locating drive shaft and rotor shaft with pump head at approx 45° to vertical, locating backplate lugs in housing.
2. Push and twist until location lever clicks into position
3. Remove by depressing location lever and twisting pump head counter clockwise 45°

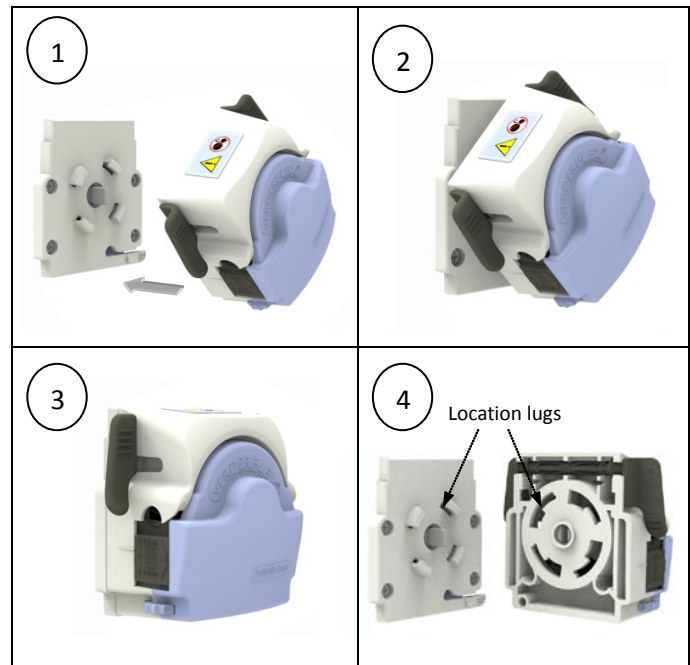

Table 4 Replacing pump head – EZ head

7.2.4 Stacking pump head – EZ head

i A pump head can be stacked over a similar stackable head as demonstrated in table 6.

1. Attach the stackable head on to the backplate (refer 7.2.3)
2. Offer the pump head over the stackable head locating the drive shaft and pump shaft with pump head at approx 45° to vertical, locating lugs in the housing.
3. Push and twist unit location lever clicks into position.
4. Remove by depressing location lever on the stackable head and twisting pump head counter clockwise 45°.

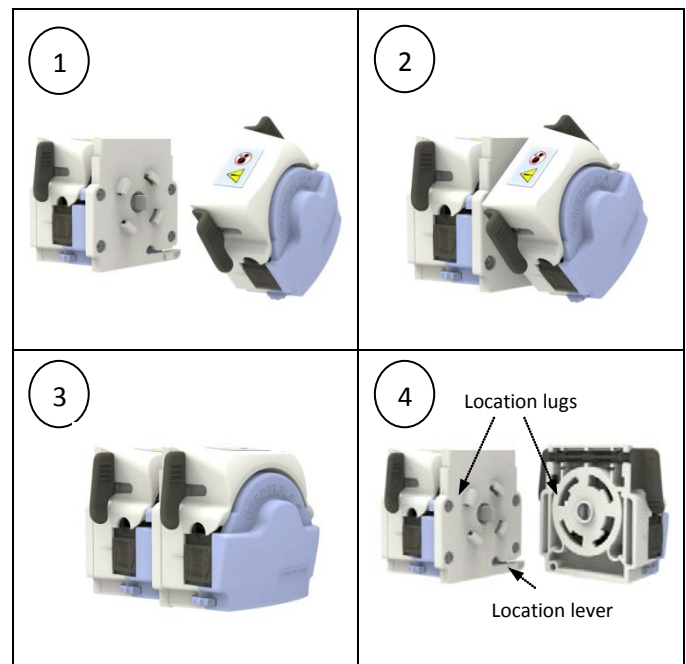

Table 5 Stacking – EZ head

7.3 S10 Head

7.3.1 Key features

ⓘ Taken from the Verderflex Smart tube pump design. The S10 includes a quick tube change, ergonomic design for ease of use.

- Flow rates up to 1,780 ml/min (28 US GPH)
- Pressures up to 2 Bar (29 PSI)
- Multi channel options
- Typically used in:
 - Chemical dosing
 - Industrial fluid transfer
 - Heavy duty environments

7.3.2 Installing the tube

1. Insert tube on top of the rollers
2. Fit the saddle to one set of dowels
3. Open up the lever and fit the claw over
4. Push the lever down to lock the saddle into place over the other set of dowels

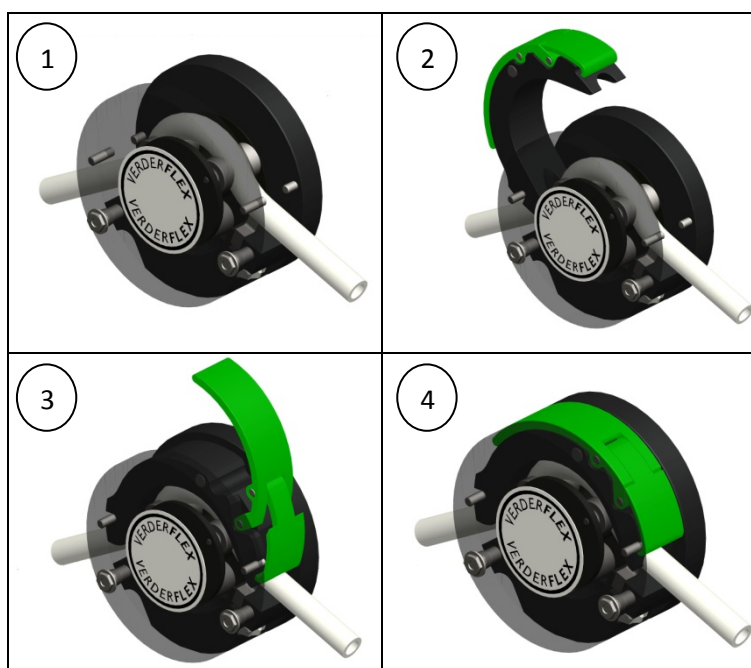

Table 6 Installing tube – S10 head

7.4 R3i head

7.4.1 Key features

ⓘ Robust design with thick wall tube for suction and pressure handling.

- Flow rates up to 3,250 ml/min (51.5 US GPH)
- Pressures up to 2 Bar (29 PSI)
- Typically used in:
 - Printing production
 - Dispensing
 - Industrial detergent applications

7.4.2 Installing the tube

1. Remove the clamp, but leave the front cover in place
2. Run the pump at low speed and carefully feed tube through the inlet
3. When tube reach outlet, use blunt end rod to guide the tube out.
4. Fit tube clamp loosely, and position tube with marked lines adjacent to edge of pump housing and tube clamp.
5. Tighten the tube clamp securely

7.4.3 Changing rotor – R3i head

1. Align grub screw hole with flat on shaft
2. Align peak of roller with peak of tube track or set rotor distance back from front of pump housing
3. Fasten grub screw securely

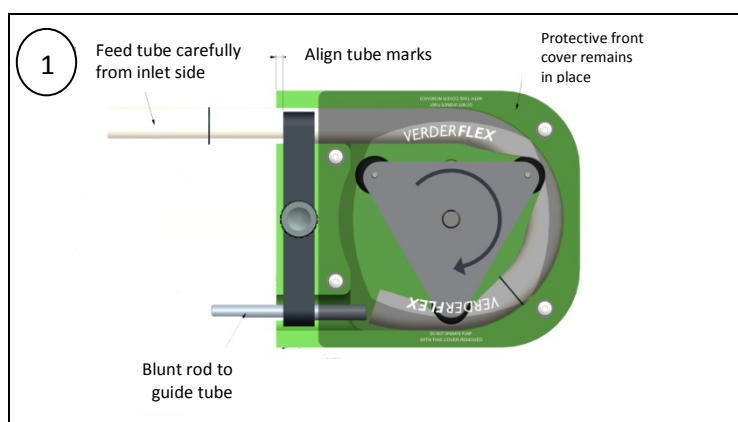

Table 7 Installing tube – R3i head

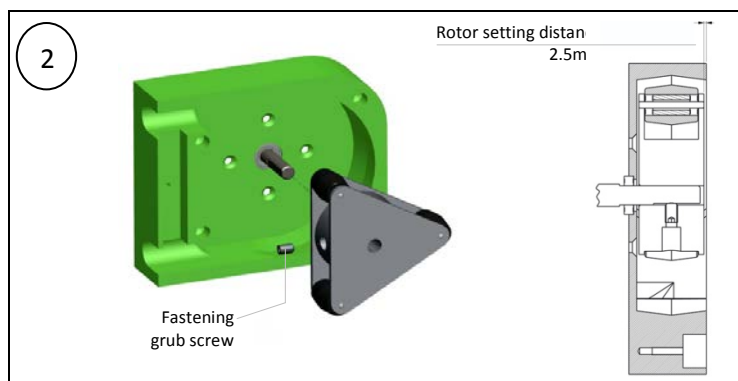
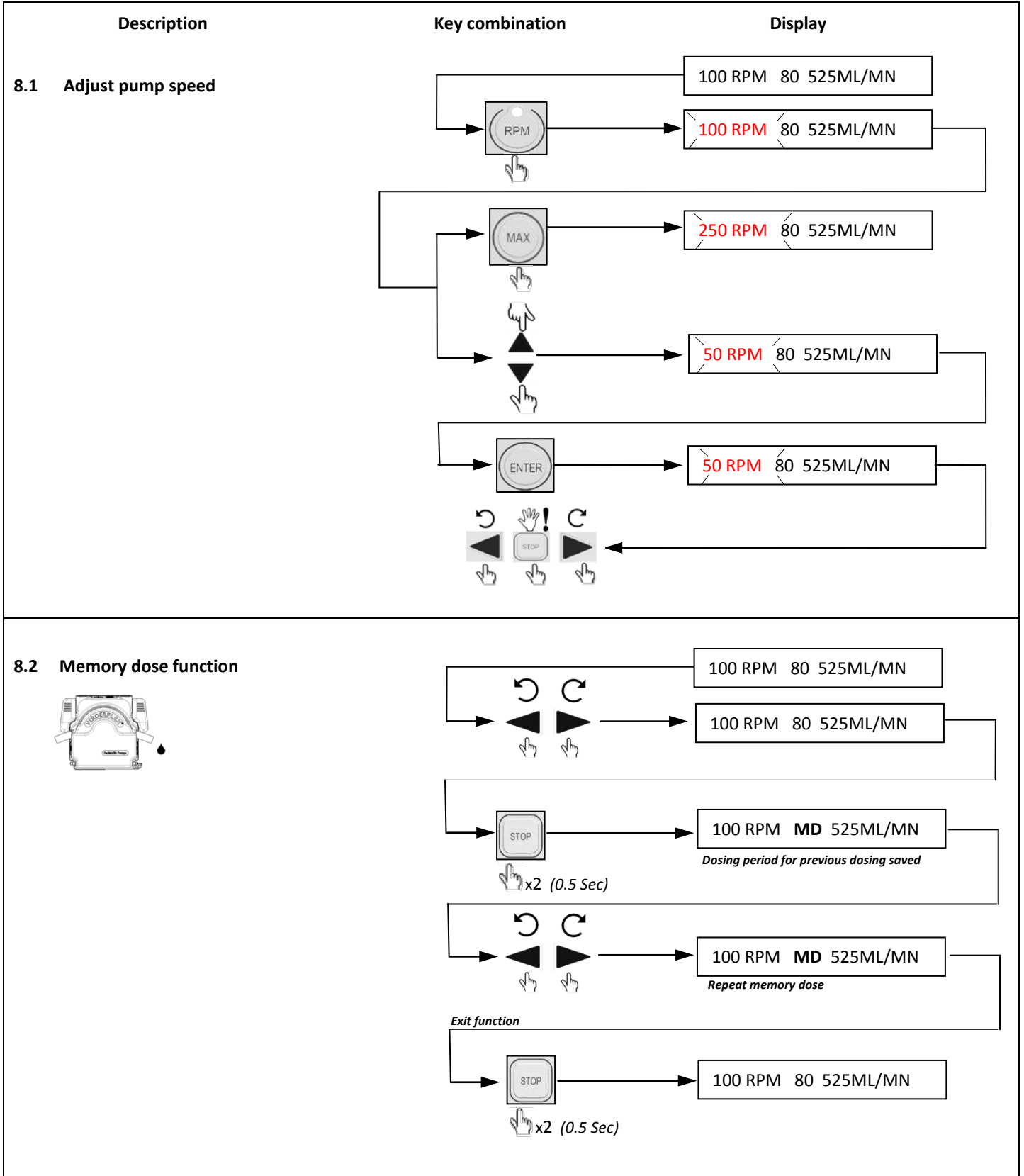
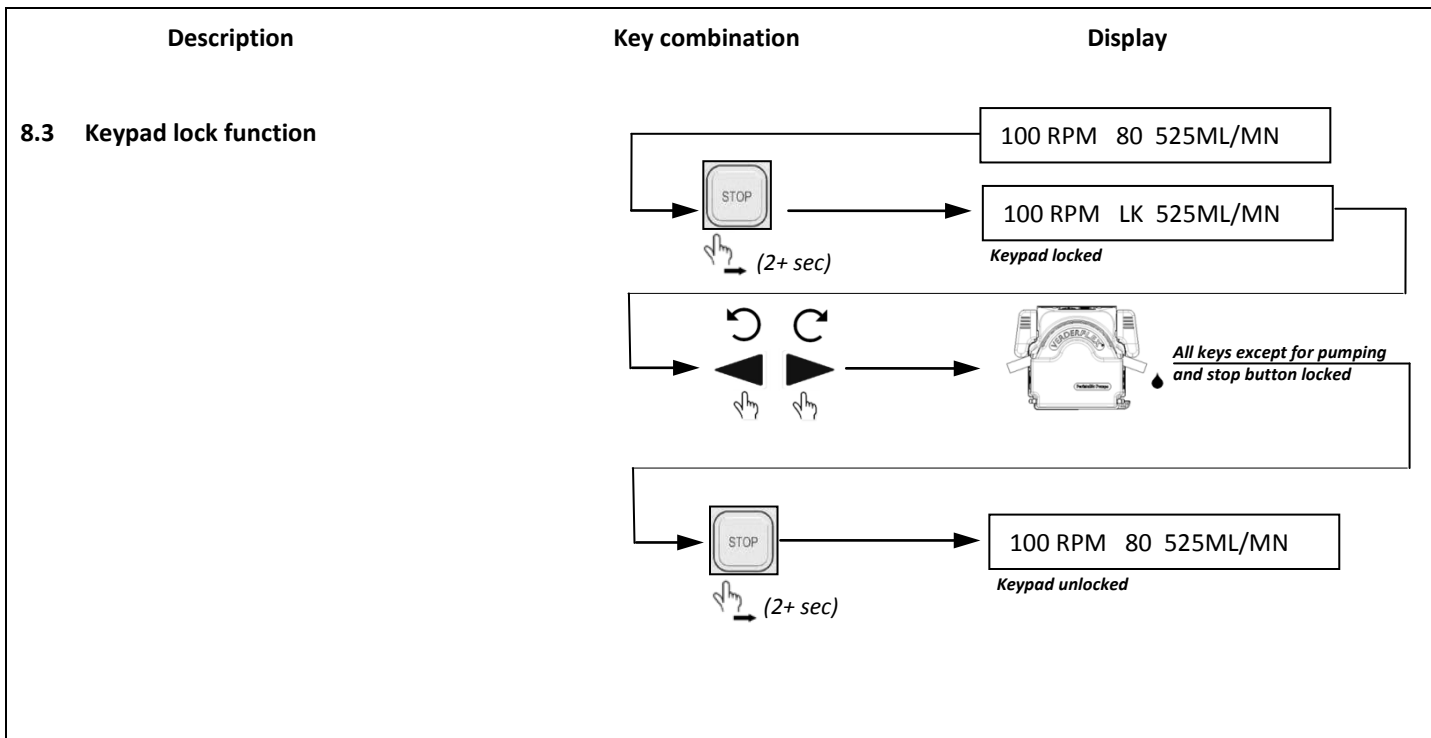

Table 8 Replacing the rotor – R3i head

8 Functions







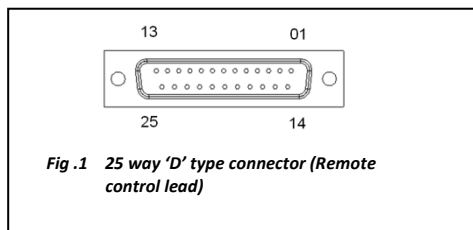



8.4 Analogue interface



PIN	Function
14	pump running +5V out
15	pump stopped +5V out
21	pump running GND
22	pump stopped GND

	Function	Connection
	Started CW	6 —○—○— 18
	Stopped CW	6 —○—○— 18
	Started CCW	7 —○—○— 19 6 —○—○— 18
	Stopped CCW	7 —○—○— 19 6 —○—○— 18
	Speed control <i>0-10V d.c</i>	13 —○— +V 25 —○— GND
	<i>Remote POT.</i>	10K (0.5W) 10 —○—○— 23 11 —○—
	<i>4-20 mA</i>	12 —○— +V 24 —○— GND

Description	Key combination	Display
8.5 IP 66 Remote speed control		<div data-bbox="1054 338 1406 389">100 RPM 80 525ML/MN</div> <div data-bbox="1054 421 1406 465">SPEED CTRL: INTERNAL</div>
		<div data-bbox="1054 555 1406 622"> <i>0 – 10V DC</i> SPEED CTRL: EXT VOLT </div> <div data-bbox="1054 651 1406 719"> <i>Remote potentiometer</i> SPEED CTRL: EXT POT. </div> <div data-bbox="1054 748 1406 824"> <i>4 – 20 mA</i> SPEED CTRL: EXT CURR </div>
		<div data-bbox="1054 913 1406 965">---- RPM 80 ---- ML/MN</div>

9 Remote Analogue/Digital Control

An external Analogue/Digital control can be used to operate the Vantage 3000 C & P range. Suitable IP66 and RS232 connectors are available for external connections.

9.1 Types of Remote control:

- Foot/Hand switch
- Analogue control:
 - 0 - 10V D.C
 - Remote potentiometer
 - 4 – 20 mA
- RS232 control

9.2 Layout of Back Plate

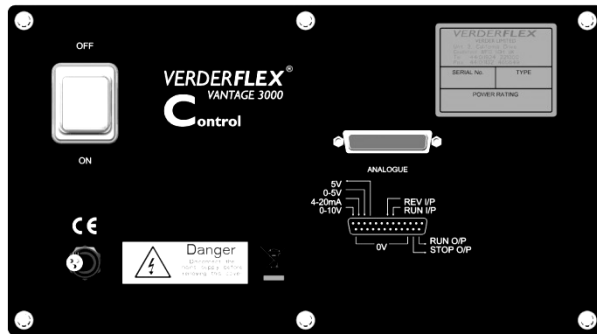

Figure 2: Back plate – Vantage 3000 C

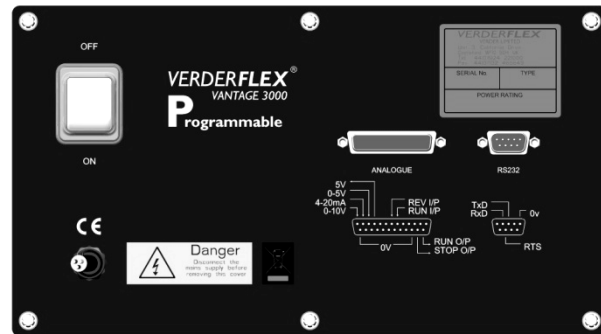

Figure 3: Back plate – Vantage 3000 P

9.3 External controls on different models

The control methods featured on each model are as listed below:

Model	Analogue/Digital Control				RS232 Control
	Footswitch	0-10V d.c	4-20mA	0-5V	
Vantage 3000 B					
Vantage 3000 C	✓	✓	✓	✓	
Vantage 3000 P	✓	✓	✓	✓	✓

Table 9: Models & Control features available

9.4 Analogue Connector:

▪ Connector Layout

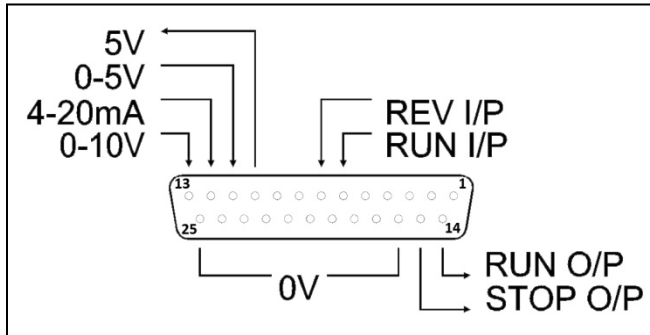

Figure 4: 25 way 'D' type connector

▪ Connector Description:

PIN	I/O	FUNCTION
6	IN	FORWARD RUN INPUT
7	IN	REVERSE RUN INPUT
10	OUT	5 VOLT SUPPLY (to potentiometer)
11	IN	0-5 VOLTS INPUT
12	IN	4-20mA INPUT
13	IN	0-10 VOLTS INPUT
14	OUT	RUNNING OUTPUT (5V)
15	OUT	STOPPED OUTPUT (5V)
16 to 25	OUT	0 VOLTS (internally connected to zero volts in the pump)

Table 10: Analogue/Digital Connector Pins

9.5 Foot /Hand switch control

Foot switches can be used to remotely turn the pump on and off, freeing the hands to perform other operations or providing ergonomic improvement at a workstation.

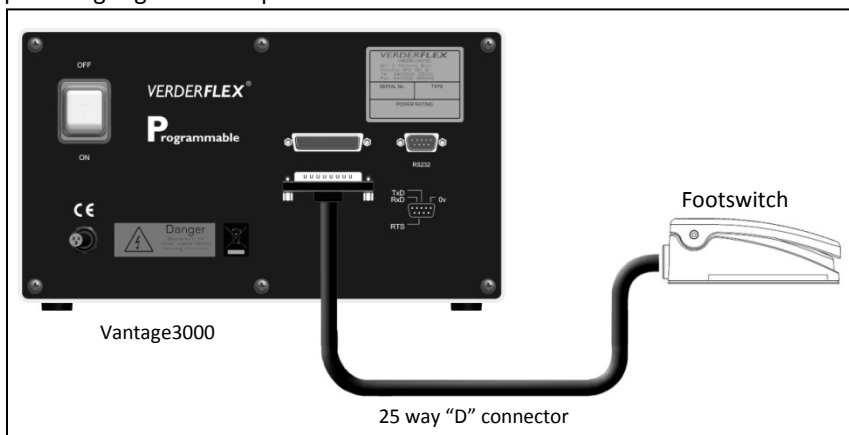

Figure 5: Connecting the footswitch

9.5.1 Connecting the foot switch

Connect the footswitch to the port marked “Analogue” of the Vantage 3000. (Refer fig.5)

Only the user can be aware of all conditions and factors present during installation, operation, and maintenance of a foot switch and surrounding work area. Therefore, only the user can determine which footswitches and which point-of-operation safeguards can properly be used in a particular application or work station.



	Function	Connection
Clockwise 	Start CW	6 ○ — ○ — ○ — 18
	Stop CW	6 ○ — ○ — ○ — 18
Counter Clockwise 	Start CCW	7 ○ — ○ — ○ — 19 6 ○ — ○ — ○ — 18
	Stop CCW	7 ○ — ○ — ○ — 19 6 ○ — ○ — ○ — 18

Table 11: Pin Function & Connection

9.6 Analogue control

Analogue control can be used to remotely control the pump speed. 0-10V or 4-20mA can be generated by a suitable transducer or a process controller such as a PLC. Potentiometer control utilizes the 5 volt source from pin 10 on the 25way “D” connector and pin 11 as a 0 – 5 volt input as shown in Table 10.

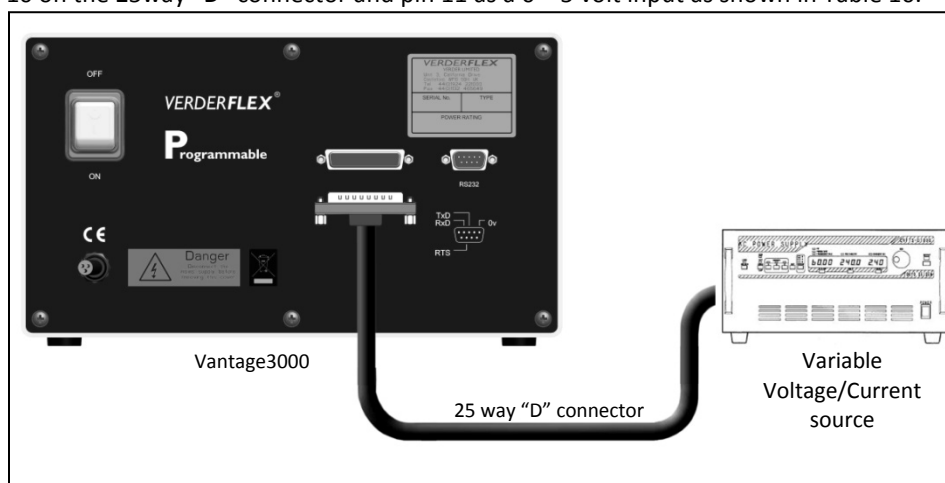

Figure 6: Connecting Variable Voltage/Current source

9.6.1 Connecting analogue control systems:

Connect the analogue control device to the Analogue port of the Vantage 3000 as shown in fig 3.



	Function	Connection
Clockwise 	Started CW	
	Stopped CW	
Counter Clockwise 	Started CCW	
	Stopped CCW	
IP 66 Remote speed control 	Speed control 0-10V d.c	13 ○ — +V 25 ○ — GND
	Potentiometer	
	4-20mA	12 ○ — I _{in} 24 ○ — GND

Table 12: Pin connection for analogue control (refer table 2 for pin description)

10 Declaration of conformity according to EC Machine Directive

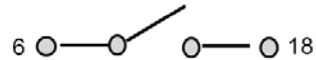
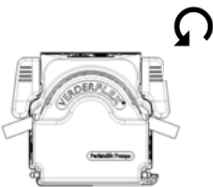
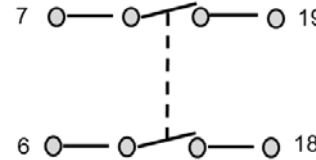
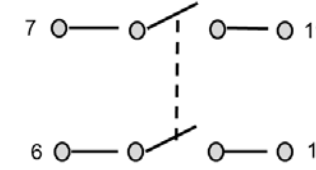
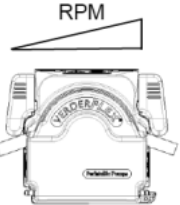
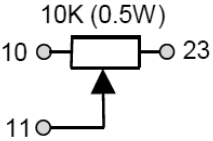

<p>EC declaration of conformity according to machine directive, appendix II A</p> <p>We, VERDER Ltd., Unit 3 California Drive, Castleford hereby declare that the following machine adheres to the relevant EC directives detailed below</p> <p>Designation Verderflex Vantage 3000 C EZ Verderflex Vantage 3000 C S10 Verderflex Vantage 3000 C R3i</p> <p>EC directives:</p> <ul style="list-style-type: none"> • Machine Directive (2006/42/EC) • Low-voltage directive (2006/95/EC) • EMC directive (2004/108/EC) <p>Applicable harmonized norms:</p> <ul style="list-style-type: none"> • EN ISO 12100: 2010 		
<p>Responsible for the documentation</p>		<p>VERDER Ltd. Unit 3 California Drive Castleford WF10 5QH UK</p>
<p>Date: 01/ 12/ 2013</p>	<p>Company stamp / signature:</p>  <p>David Sampson <i>Head of Development/Construction</i></p>	<p>Company stamp / signature:</p>  <p>David Hoyland Head of Quality</p>

Table 13 Declaration of conformity according to EC Machine Directive

